

# PRESSURE SWITCHES

	DESCRIPTION	PRESSURE RANGE bar	CONNECTION thread	DEVICE	PAGE
<b>PRESSURE</b>	miniature, low cost	0.2 ... 2 / 200	G $\frac{1}{8}$ and G $\frac{1}{4}$	DS08 ... DS46	<b>12.02</b>
	many variations	0.1 ... 1 / 200	G $\frac{1}{8}$ m and G $\frac{1}{4}$ m	DS16 ... DS18	<b>12.03</b>
	low pressure, handwheel	0.005 ... 0.02 / 12	G $\frac{1}{8}$ m and G $\frac{1}{4}$ m	DSP	<b>12.05</b>
	low pressure, plastic	0.003 ... 0.03 / 7	$\frac{1}{8}$ "NPT m	F4200	<b>12.06</b>
	small hysteresis	0.014 ... 0.14 / 7	$\frac{1}{8}$ "NPT m	F4300	<b>12.07</b>
	high accuracy	0.004 ... 0.012 / 0.15	nipple	F4000	<b>12.08</b>
	for PCB	0.014 ... 0.14 / 7	nipple	F4400	<b>12.08</b>
<b>VACUUM</b>	many options	-0.2 ... -1	G $\frac{1}{8}$	DS15	<b>12.03</b>
	with handwheel	-0.005... -0.02 / -0.7	G $\frac{1}{8}$ m and G $\frac{1}{4}$ m	DSP-V	<b>12.05</b>
	plastic	-0.001... -0.01 / -1	$\frac{1}{8}$ "NPTm	F4200-X	<b>12.06</b>
	also flangeable	-0.007... -0.17 / -1	$\frac{1}{8}$ "NPTm	F4300-X	<b>12.07</b>
	with adjustable hysteresis	-0.007... -0.38 / -0.5	nipple	F4000-X	<b>12.08</b>
	with small hysteresis	-0.007... -0.17 / -1	nipple	F4400-X	<b>12.08</b>
<b>DIFFERENTIAL PRESS.</b>	with handwheel	5 ... 20 / 50 mbar	nipple	DSP-W	<b>12.05</b>
<b>ATEX</b>	dust, EXII 3D IP65 T90	0.3 ... 1.5 / 150	G $\frac{1}{4}$ male	DS34	<b>12.04</b>
	gas, EXII 2G ExdII C T6	1 ... 6 / 400	G $\frac{1}{4}$ female	DS35	<b>12.04</b>
	gas, EXII 2G Ex ia T4	0.005 ... 0.02 / 12	G $\frac{1}{8}$ m and G $\frac{1}{4}$ m	DSP	<b>12.05</b>
<b>PNEUMAT. SIGNAL</b>	pressure	0.07 ... 0.35 / 7	$\frac{1}{8}$ "NPTm	PP700/PP701	<b>12.09</b>
	vacuum	-0.03 ... 0.17 / -0.85	$\frac{1}{8}$ "NPTm	VP700/VP701	<b>12.09</b>
<b>ELECTRICAL SIGNAL</b>	with pressure indicator	-1 ... 1 / 10	G $\frac{1}{8}$ m	DSB/DSC	<b>12.10</b>
<b>STAINLESS STEEL</b>	many options	0.5 ... 5 / 200	G $\frac{1}{4}$ m	DS18	<b>12.03</b>
	low pressure, handwheel	0.005 ... 0.02 / 12	G $\frac{1}{8}$ m and G $\frac{1}{4}$ m	DSP	<b>12.05</b>

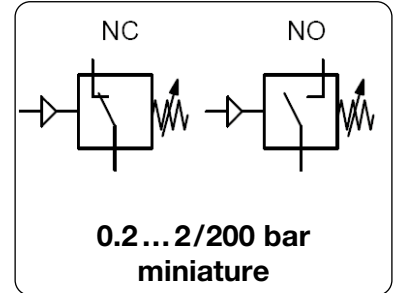

<b>Description</b>	The small-sized pressure switch closes or opens an electrical contact when the desired pressure is reached. If it falls below, the contact will be reset.		
<b>Media</b>	DS10: compressed air	DS13: compressed air and water	All others: compressed air, water hydraulic oil
<b>Burst pressure</b>	min. 20 bar,	DS13: max. 15 bar,	DS40C/D: max. 250 bar
<b>Contact</b>	silver-coated, max. 2A Ohm resistive load, max. 100 VA		
<b>Hysteresis</b>	< 10% FS, DS10 and D40: 10 ... 15% FS		
<b>Mounting position</b>	any		
<b>Life span</b>	10 <sup>6</sup> operating cycle for max. 200 switches / min		
<b>Protection class</b>	IP 00, with protective cap IP 65		
<b>Tolerance</b>	± 0.2 bar at 0.2 ... 2 bar,	± 0.5 bar at 1 ... 10 bar	<b>Voltage</b> 42 V
<b>Electrical connection</b>	contact pin 2 x 6.3 x 0.8 except for DS10 and DS40: screwed connection M2		
<b>Temperature range</b>	-25 °C to 85 °C / -13 °F to 185 °F DS13: -20 °C bis 75 °C / -4 °F to 167 °F		
<b>Material</b>	Body:	brass for DS08, DS14, DS46	steel for DS25, DS40
		plastic for DS13	
	Elastomer:	NBR/Buna-N, optionally EPDM, FKM and Kalrez	



Switches



12

Dimensions			Body	Electr.	Connection	Pressure	Measurement	Order number	
A/F	B	C	made	connection	thread	transmission	range	contact	contact
mm	mm	mm	of		G	by	bar	NO	NC

Mini-Pressure switch, 42 V								NBR/Buna-N	DS	
17	13	22	brass	flat plug	G $\frac{1}{4}$	diaphragm	0.3 ... 1.0	2	DS08-21A DS08-21B	DS08-20A DS08-20B
19	16	25	brass	screw connection	G $\frac{1}{8}$	diaphragm	1.0 ... 10		DS10-11B	
14	23	37	plastic	flat plug	G $\frac{1}{8}$	diaphragm	0.2 ... 1.0	2 8	DS13-11A DS13-11B	DS13-10A DS13-10B
19	21	34	brass	flat plug	G $\frac{1}{8}$	diaphragm	0.3 ... 1.0	2 10	DS14-11A DS14-11B	DS14-10A DS14-10B
24	20	34	steel	flat plug	G $\frac{1}{8}$	diaphragm	0.2 ... 1.0	2 10	DS25-11A DS25-11B	DS25-10A DS25-10B
24	22	31	steel	screw connection	G $\frac{1}{8}$	diaphragm	0.3 ... 1.0	2 10	DS40-11A DS40-11B	DS40-10A DS40-10B
		37				piston	10 ... 50	70	DS40-11C	DS40-10C
						piston	50 ... 200		DS40-11D	DS40-10D
27	29	35	brass	flat plug	G $\frac{1}{4}$	diaphragm	0.2 ... 0.5	2 10	DS46-21A DS46-21B	DS46-20A DS46-20B



**Special options,** add the appropriate letter

<b>G<math>\frac{1}{4}</math> male</b>	connection thread	only for DS10 to DS40	DS...-2..
<b>FKM elastomer</b>	for diaphragm	not for DS13	DS...-...V
	for piston	only for DS40 (C/D)	DS...-...V
<b>EPDM elastomer</b>		only for DS10 and DS40	DS...-...E
<b>Kalrez elastomer</b>		only for DS10 and DS40	DS...-...K
<b>gold contact</b>		not for DS08	DS...-...G

**Accessories,** enclosed

<b>protection cap</b>	for DS10	<b>K210</b>	for DS08, DS13 and DS14	<b>K214</b>
	for DS25	<b>K250</b>	for DS40	and DS46
				<b>K400</b>

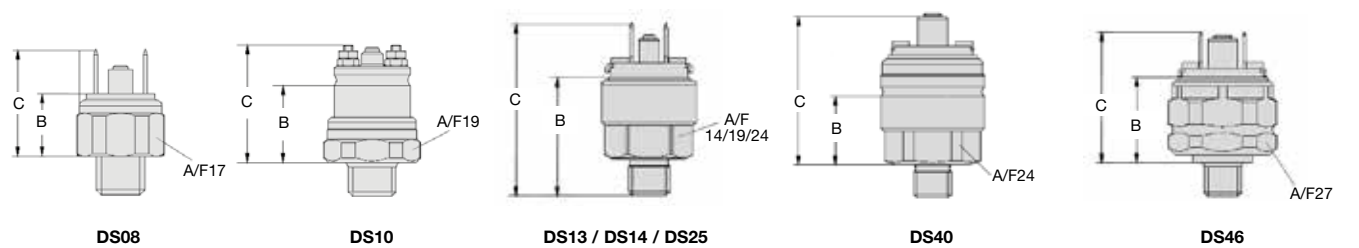

PDF CAD  
www.aircom.net

Order example:  
DS08-21A

# PRESSURE SWITCH, UP TO 600 MBAR

## DS15...DS18

<b>Description</b>	The pressure switch closes or opens an electrical contact when the desired pressure is reached. If it falls below, the contact will be reset.	
<b>Media</b>	compressed air, non-corrosive gases or liquids	
<b>Overpressure</b>	see chart for max. static pressure, dynamic pressures are 50% lower	
<b>Switch contact</b>	DS15/16: NO contact, optionally NC contact	DS17/18: SPDT switch
<b>Contact load</b>	DS15/16: 2 A at 42 V DC, DS17: 4 A at 42 V DC, DS18: 4 A at 250 V AC	
<b>Electrical connector</b>	DS15/16: screw terminal, DS17/18: spade terminal 6.3 x 0.8 mm, optionally also for DS15/16	
<b>Hysteresis</b>	DS15/16: 5...20%, DS17/18: adjustable to 10...30% by factory	
<b>Life cycle</b>	10 <sup>6</sup> switching cycles at < 50 bar	Switching frequency max. 200 cycles/min
<b>Vibration resistance</b>	10 g at 5...200 Hz	Shock resistance 30 g
<b>Certifications</b>	CSA-certified and UL-listed	Mounting position any
<b>Protection class</b>	IP 00, with coupling socket IP 65	
<b>Temperature range</b>	-30 °C to 100 °C / -22 °F to 212 °F for NBR/Buna-N, -30 °C to 120 °C / -22 °F to 248 °F for EPDM, -5 °C to 120 °C / 23 °F to 248 °F for FKM	
<b>Material</b>	Body: steel, brass at DS15, optionally stainless steel at DS18 Elastomer: NBR/Buna-N, optionally EPDM or FKM	

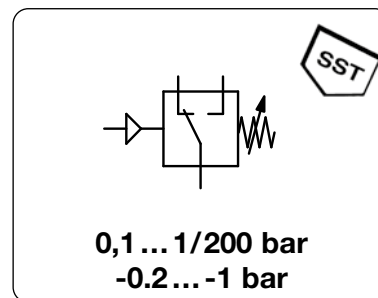

Switches  
12

Pressure transmission by	Overpressure protection < bar	Measuring tolerance ± bar	Measurement range bar	Order number
--------------------------	-------------------------------	---------------------------	-----------------------	--------------

Pressure switch G <sup>1</sup> / <sub>4</sub> m, NO 42V	steel, NBR/Buna-N, without protective cap	DS16
diaphragm	300	0.2
		0.5
		1.0
		2.0
piston	600	5.0



DS16

Pressure switch G <sup>1</sup> / <sub>4</sub> m, SPDT 42V	steel, NBR/Buna-N, with coupling socket	DS17
diaphragm	100	0.2
	100	0.5
	300	1.0
	300	3.0
	300	5.0
piston	600	5.0



DS17

Pressure switch G <sup>1</sup> / <sub>4</sub> m, SPDT 250V	steel, NBR/Buna-N, with coupling socket	DS18
diaphragm	100	0.2
	300	1.0
	300	3.0
	300	5.0
piston	600	5.0



DS18

DS15

Vacuum switch G <sup>1</sup> / <sub>8</sub> f, NO 42V	brass, FKM, without protective cap	DS15
diaphragm	20	0.1

### Special options, add the appropriate letter

<b>EPDM elastomer</b>		not for DS15	DS1.-.E
<b>FKM elastomer</b>		not for DS15	DS1.-.V
<b>free of oil and grease</b>	suitable for oxygen, max. 10 bar		DS1.-.L
<b>NC contact</b>	instead of normally open contact	for DS15 and DS16	DS1.-.1
<b>spade terminal</b>	6.3 x 0.8 mm, galvanised	for DS15 and DS16	DS1.-.T
<b>600 bar overpressure</b>	maximum	for DS16	DS16-.U
<b>gold contact</b>	max. 24 V AC/DC, 50 mA	for DS17	DS17-.G
<b>250 V</b>	max. voltage	for DS17	DS17-.W
<b>stainless steel body</b>	0.5...5/200 bar	for DS18	DS18-.S
<b>factory-set pressure</b>	pressure indication falling pressure VF . . rising pressure		DS1.-.VS . .

### Accessories, enclosed

<b>protection cap</b>	straight, IP65	for DS15 and DS16	DS16-KAP
-----------------------	----------------	-------------------	----------

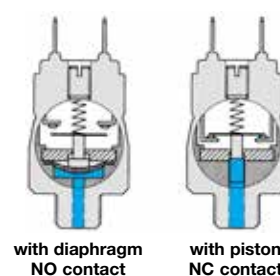
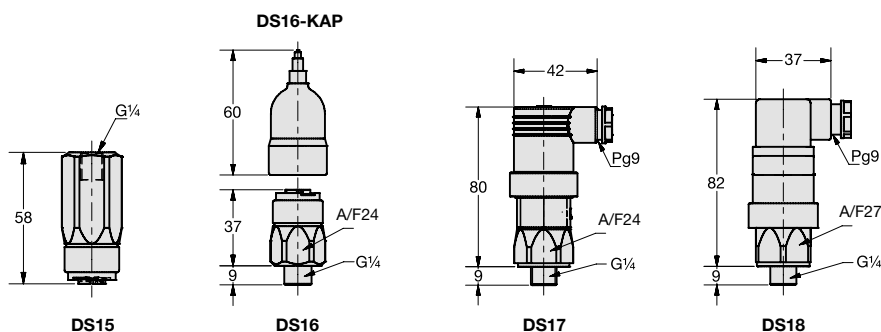

PDF CAD  
www.aircom.net

Order example:  
DS16-A

<b>Description</b>	The pressure switch closes or opens an electrical contact when the desired pressure is reached. When the pressure falls below the adjusted setpoint, the contact will be reset.	
<b>Media</b>	compressed air or non-corrosive gases	
<b>Overpressure</b>	see chart for max. static pressure,	
<b>Contact load</b>	DS34: 1 A at 230 V AC,	<b>Switch contact</b> SPDT switch
<b>ATEX version</b>	DS34: II 3D IP 65 T90°C	dynamic pressures are 50% lower
<b>Electrical connector</b>	3-wire connection cable, length 2 m, cross-sectional area 0.75 mm <sup>2</sup> at DS34 or 0.5 mm <sup>2</sup> at DS35	DS35: 2 A at 230 V AC
<b>Hysteresis</b>	< 25% FS, ca. 10% FS in the lower range	DS35: II 2G Ex d II C T6/T5
<b>Life cycle</b>	10 <sup>8</sup> switching cycles at < 50 bar	<b>Switching frequency</b> 200 cycles/min
<b>Vibration resistance</b>	10 g at 5...200 Hz	<b>Shock resistance</b> 30 g
<b>Mounting position</b>	any	<b>Protection class</b> IP 65
<b>Temperature range</b>	-20 °C to 80 °C / 23 °F to 176 °F for NBR/Buna-N and EPDM	
	-5 °C to 80 °C / 23 °F to 176 °F for FKM	
<b>Material</b>	Body: zinc-plated steel at DS34, aluminium at DS35	optionally EPDM or FKM
	Elastomer: NBR/Buna-N,	

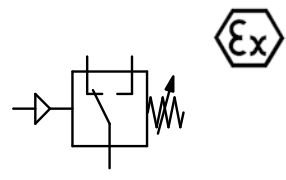

**0.3 ... 1.5 / 400 bar  
dust- and gas-proof**

Switches  
12

Pressure transmission by	Overpressure protection < bar	Measurement tolerance ± bar	Measurement range bar	Order number
--------------------------	-------------------------------	-----------------------------	-----------------------	--------------

Pressure switch G <sup>1</sup> / <sub>4</sub> male	SPDT switch 230 V AC, 1A	dust-proof	II 3D IP 65 T90°C	DS34
diaphragm	300	0.2	0.3 ... 1.5	DS34-A
		0.5 - 1.0	1.0 ... 10	DS34-B
		1.0	10 ... 20	DS34-C
		2.0	20 ... 50	DS34-D
piston	600	5.0	50 ... 150	DS34-E



DS34, dust protection

Pressure switch G <sup>1</sup> / <sub>4</sub> female	SPDT switch 230 V AC, 1A	gas-proof	II 2G Ex d II C T6/T5	DS35
diaphragm	200	0.5	1 ... 6	DS35-B
		3.0	5 ... 50	DS35-D
piston	600	3 - 5	20 ... 100	DS35-E
		5 - 9	100 ... 400	DS35-K



DS35, gas protection

### Special options, add the appropriate letter

<b>EPDM elastomer</b>	-20 °C to 80 °C / -4 °F to 176 °F	DS3. - . E
<b>FKM elastomer</b>	- 5 °C to 80 °C / 23 °F to 176 °F	DS3. - . V
<b>free of oil and grease</b>	suitable for oxygen, max. 10 bar, diaphragm version only	DS3. - . L
<b>adjusted switchpoint</b>	± 5%, indicate on order	DS3. - . X

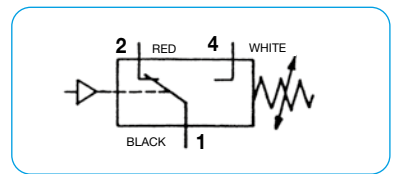
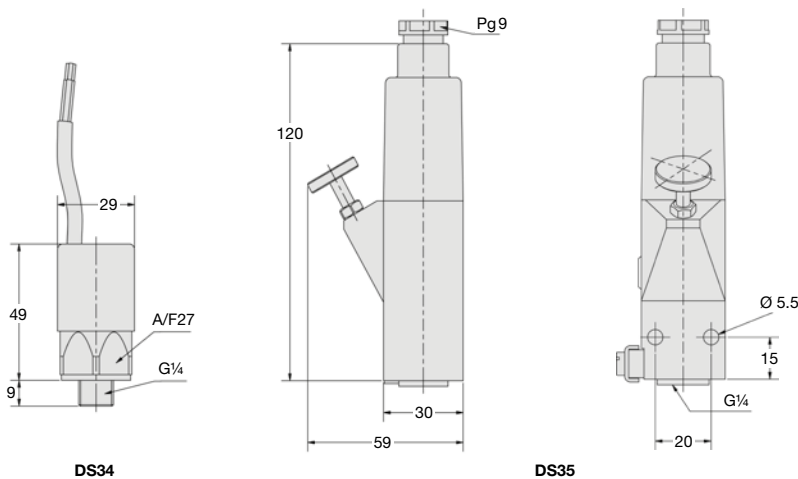

pin configuration DS34

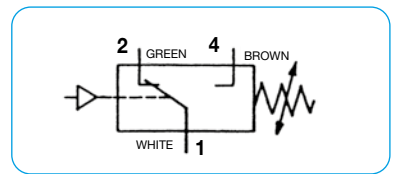

pin configuration DS35

<b>Description</b>	Adjustable pressure switch for monitoring pressure, vacuum and differential pressure. From the 6 bar device on two turns of the adjusting knob are necessary for the whole adjustment range, so the scale on the knob is inappropriate.		
<b>Media</b>	compressed air, non-corrosive gases or liquids	<b>Overpressure</b>	see chart
<b>Switch contact</b>	SPDT switch with silver contact, optionally gold contact	<b>Vibration resistance</b>	20 g
<b>Contact load</b>	2 A at 24 V DC, 6 A at 250 V AC	<b>Switching time</b>	30 ms
<b>Electrical connector</b>	AMP spade terminal, 6.3 x 8 mm, according to DIN 46244	<b>Hysteresis</b>	see chart
<b>Life cycle</b>	10 <sup>6</sup> switching cycles	<b>Protection class</b>	IP 65 w/ coupling socket
<b>Certifications</b>	VDE, TÜV design test, optionally Atex	<b>Measurement range</b>	-20 °C to 85 °C / -4 °F to 185 °F for NBR/Buna-N, EPDM and polyamide, up to 130 °C / 266 °F for FKM
<b>Mounting position</b>	any, but indication needed for switch point < 100 mbar	<b>Order number</b>	
<b>Temperature range</b>	-20 °C to 85 °C / -4 °F to 185 °F for NBR/Buna-N, EPDM and polyamide, up to 130 °C / 266 °F for FKM		
<b>Material</b>	Body: Zytel, a high-quality polyamide Elastomer: NBR/Buna-N, optionally EPDM, FKM or special FKM (saturated steam-resistant) Pressure connection: brass, at DSP-W polyamide, optionally stainless steel or PVDF		

**5 ... 20 mbar / 12 bar**  
**-5 ... -20 / -700 mbar**

Switches



12

Dimensions		Overpressure protection	hysteresis max.	Measurement range	Order number
B	Ø	< bar	mbar / bar	mbar / bar	
mm	mm				

Pressure switch G <sup>1</sup> / <sub>4</sub> male, for low pressure			wetted sections: brass and NBR/Buna-N, scale toleranz 10%		DSP-D
68	45	0.5	3 mbar	5 ... 20 mbar	DSP-DB2
		0.5	5 mbar	10 ... 50 mbar	DSP-DB5
		0.5	10 mbar	25 ... 100 mbar	DSP-DC1
		1.0	20 mbar	50 ... 250 mbar	DSP-DC2
		1.0	50 mbar	100 ... 500 mbar	DSP-DC5
		10	150 mbar	0.25 ... 1.0 bar	DSP-D01
		10	250 mbar	0.5 ... 1.5 bar	DSP-D02
		10	500 mbar	1 ... 3.0 bar	DSP-D03
		25	0.5 / 2 bar*	1 ... 6.0 bar	DSP-D06
		25	0.5 / 2 bar*	4 ... 9.0 bar	DSP-D09
		25	0.5 / 2 bar*	7 ... 12 bar	DSP-D12



DSP-D09

Pressure switch G <sup>1</sup> / <sub>4</sub> male			wetted sections: brass and NBR/Buna-N, scale toleranz 10%		DSP-V
68	45	0.5	3 mbar	-5 ... - 20 mbar	DSP-V02
		0.5	5 mbar	-10 ... - 50 mbar	DSP-V05
		0.5	10 mbar	-25 ... -100 mbar	DSP-V10
		0.5	20 mbar	-50 ... -125 mbar	DSP-V12
		1.0	25 mbar	-75 ... -200 mbar	DSP-V20
		1.0	30 mbar	-100 ... -300 mbar	DSP-V30
		1.0	75 mbar	-200 ... -500 mbar	DSP-V50
		1.0	75 mbar	-300 ... -700 mbar	DSP-V70



DSP-W

Differential press. switch, nipple Ø 6.5			wetted sections: polyamide and NBR/Buna-N, scale toleranz 10%		DSP-W
77	45	0.1	3 mbar	5 ... 20 mbar	DSP-W20
		0.1	5 mbar	10 ... 50 mbar	DSP-W50



DSQ-KAP5

DSQ-KAP4

## Special options, add the appropriate letter

factory-set pressure		DSQ- . . .
G <sup>1</sup> / <sub>8</sub> male	pressure port thread, (not for DSP-W)	DSP- . . . 1
stainless steel port	pressure port thread, 1.4401, (not for DSP-W)	DSP- . . . S
FKM elastomer	max. 130 °C / 266 °F	DSP- . . . V
EPDM elastomer		DSP- . . . E
increased overpressure	max. 4 bar for pressure measurement range < 1 bar	DSP- . . . U
gold contact	max. 24 V AC, 100 mA	DSP- . . . G
Ex-i-Atex	II 1/2G Ex ia IIB T4 and II 1/2G Ex ia IIC T4	DSP- . . . EX
Ex-ii-Atex	II 1/2G Ex ia IIB T4 and II 1/2G Ex ia IIC T4	DSP- . . . SEX

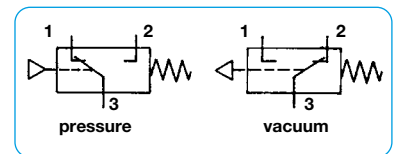

pin configuration

## Accessories, enclosed

mounting bracket	made of steel, including nut	for G <sup>1</sup> / <sub>4</sub>	<b>BW14-01</b>
protection cap	angular, cable feedthrough Ø 5 mm	IP44	<b>DS-KAP4</b>
	angular, high-strength cable gland Pg 9	IP54	<b>DS-KAP5</b>
		IP65	<b>DS-KAP6</b>

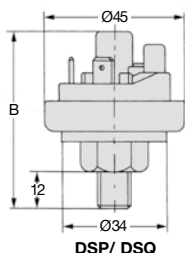

DSP/ DSQ

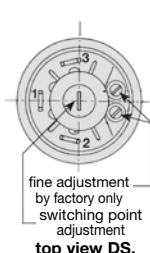

top view DS.

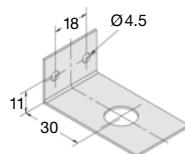

BW14-01

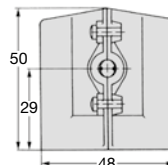

DS-KAP4

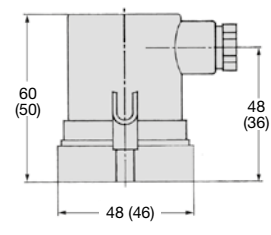

DS-KAP5 (-KAP6)

\* 0.5 bar at the beginning, 2 bar at the end of the pressure range



<b>Description</b>	High-precision pressure and vacuum switch with electrical outlet signal. The microswitch satisfies UL and CSA regulations. Polysulphone of the body approved by National Sanitation Foundation. The switch also complies with FDA regulations and is suitable for water and food products.		
<b>Media</b>	compressed air, non-corrosive gases or liquids		
<b>Switch contact</b>	micro SPDT switch, covered by plastic cap		
<b>Contact load</b>	3 A at 230 V AC or 1.2 A at 125 V DC 10 A at 230 V AC or 0.5 A at 125 V DC		
<b>Electrical connector</b>	0.187" (4.75 mm) quick connector for Molex connector		
<b>Repeatability</b>	± 2% FS		
<b>Certifications</b>	CSA-certified and UL-listed		
<b>Switching time</b>	25 ms		
<b>Mounting position</b>	any		
<b>Temperature range</b>	4 °C to 66 °C / 40 °F to 150 °F		
<b>Material</b>	Body: polysulphone	Spring: stainless steel	Media non-contact parts: nylon, carbon fibre nylon, acetal
	Diaphragm: polyurethane		

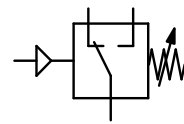

**3 ... 30 mbar / 7 bar**  
**-1 ... -10 mbar / -1 bar**

Description	Contact load	Hysteresis typical	Hysteresis max.	Over-pressure max. bar	Measurement range bar	Order number
	max. A	mbar	mbar	max. bar	bar	

Pressure and Vacuum Switch	pressure port 1/8" NPT male, with covering cap, SPDT switch	F4200
pressure switch	3	3 10 1 0.003 ... 0.03 <b>F4200- 0,5PT</b>
	10	7 20 2 0.014 ... 0.14 <b>F4200- 2PT</b>
	10	30 50 2 0.035 ... 0.35 <b>F4200- 5PT</b>
	10	70 110 3 0.035 ... 1.0 <b>F4200- 15PT</b>
	10	120 160 4 0.035 ... 2.1 <b>F4200- 30PT</b>
	10	240 350 8 0.035 ... 4.2 <b>F4200- 60PT</b>
vacuum switch	10	400 500 8 0.070 ... 7.0 <b>F4200-100PT</b>
	3	1 3 -0.3 -0.001 ... -0.01 <b>F4200-X 4PT</b>
	10	17 27 -1 -0.007 ... -0.17 <b>F4200-X 5PT</b>
	10	34 50 -1 -0.015 ... -0.34 <b>F4200-X10PT</b>
10	68 100 -1 -0.050 ... -1.00 <b>F4200-X30PT</b>	



F4200-100PT



F4200-60FM



F4200-30PT



F4200-100MM

### Special options, add or change the appropriate letter

<b>flush mounting</b>	barbed fitting made of nylon, Ø 1/16", Ø 2 mm	F4200- ... <b>FMB80</b>
<b>panel mounting</b>	barbed fitting made of nylon, Ø 1/16", Ø 2 mm	F4200- ... <b>PMB80</b>
<b>manifold mounting</b>		F4200- ... <b>MM</b>
<b>barbed fittings</b>	for FM and PM, made of nylon, Ø 1/16", Ø 2 mm	F4200- ... <b>B80</b>
	nylon, Ø 1/8", Ø 4 mm	F4200- ... <b>B85</b>
	polysulphone, Ø 1/16", Ø 2 mm	F4200- ... <b>P80</b>
	polysulphone, Ø 1/8", Ø 4 mm	F4200- ... <b>P85</b>
<b>gold contact</b>		F4200- ... <b>1B</b>
<b>factory-set switchpoint</b>	± 5%, indicate on order	F4200- ... <b>X</b>
<b>free of oil and grease</b>	specially cleaned, suitable for oxygen	F4200- ... <b>L</b>

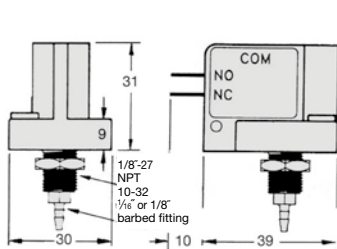

F4200 - PM

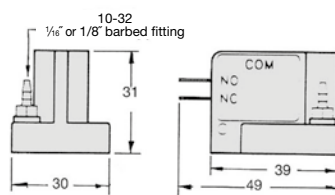

F4200 - FM

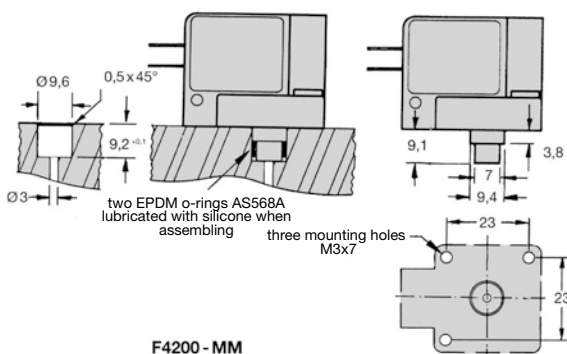

F4200 - MM

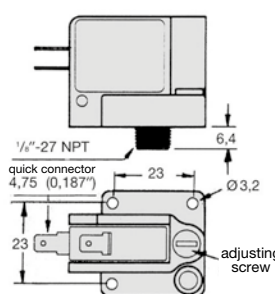

F4200 - PT

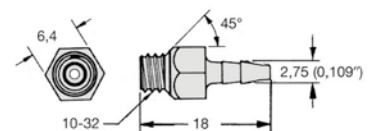

B80 / P80

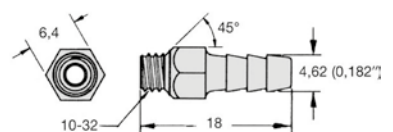

B85 / P85



# PRESSURE AND VACUUM SWITCH WITH LOW HYSTERESIS, TYPE "AIRROL®"

F4300

<b>Description</b>	Pressure and vacuum switch with electrical outlet signal and low hysteresis. The microswitch satisfies UL and CSA regulations. Polysulphone of the body approved by National Sanitation Foundation. The switch also complies with FDA regulations and is suitable for water and food products.		
<b>Media</b>	compressed air, non-corrosive gases or liquids		
<b>Switch contact</b>	micro SPDT switch, covered by plastic cap		
<b>Contact load</b>	3 A or 4 A at 230 V AC, see chart		
<b>Electrical connector</b>	0.110" (2.8 mm) quick connector for Molex/ETC connector		
<b>Repeatability</b>	± 2% FS		
<b>Certifications</b>	CSA-certified and UL-listed		
<b>Switching time</b>	25 ms		
<b>Mounting position</b>	any		
<b>Temperature range</b>	4 °C to 66 °C / 40 °F to 150 °F		
<b>Material</b>	Body: polysulphone	Spring: stainless steel	
	Diaphragm: polyurethane	Media non-contact parts: nylon, carbon fibre nylon, acetal	

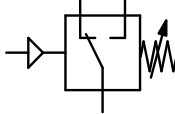

**14 ... 140 mbar / 7 bar**  
**-7 ... -170 mbar / -1 bar**

Switches  
12

Description	Contact load	Hysteresis typical	Hysteresis max.	Over-pressure max. bar	Measurement range bar	Order number
	max. A	mbar	mbar	max. bar	bar	

Pressure / vacuum switch, low hysteresis	Contact load	Hysteresis typical	Hysteresis max.	Over-pressure max. bar	Measurement range bar	Order number
pressure switch	3	7	14	2	0.014 ... 0.14	F4300- 2PT
	4	14	24	2	0.035 ... 0.35	F4300- 5PT
	4	30	41	3	0.035 ... 1.0	F4300- 15PT
	4	40	70	4	0.035 ... 2.1	F4300- 30PT
	4	100	170	8	0.035 ... 4.2	F4300- 60PT
	4	140	240	8	0.070 ... 7.0	F4300-100PT
vacuum switch	4	10	20	-1	-0.007 ... -0.17	F4300-X 5PT
	4	20	34	-1	-0.015 ... -0.34	F4300-X10PT
	4	34	50	-1	-0.050 ... -1.00	F4300-X30PT



## Special options, add or change the appropriate letter

<b>flush mounting</b>	barbed fitting made of nylon, Ø 1/16", Ø 2 mm	F4300-...FMB80
<b>panel mounting</b>	barbed fitting made of nylon, Ø 1/16", Ø 2 mm	F4300-...PMB80
<b>manifold mounting</b>		F4300-...MM
<b>barbed fittings</b>	for FM and PM, made of nylon, Ø 1/16", Ø 2 mm	F4300-...B80
	nylon, Ø 1/8", Ø 4 mm	F4300-...B85
	polysulphone, Ø 1/16", Ø 2 mm	F4300-...P80
	polysulphone, Ø 1/8", Ø 4 mm	F4300-...P85
<b>gold contact</b>		F4300-...1B
<b>factory-set switchpoint</b>	± 5%, indicate on order	F4300-...X
<b>free of oil and grease</b>	specially cleaned, suitable for oxygen	F4300-...L

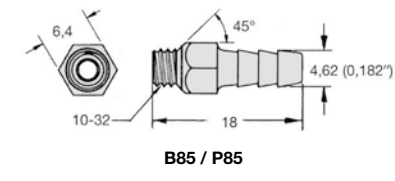
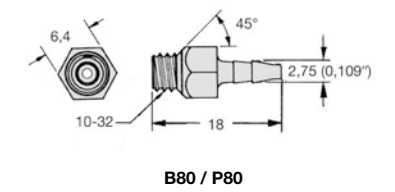
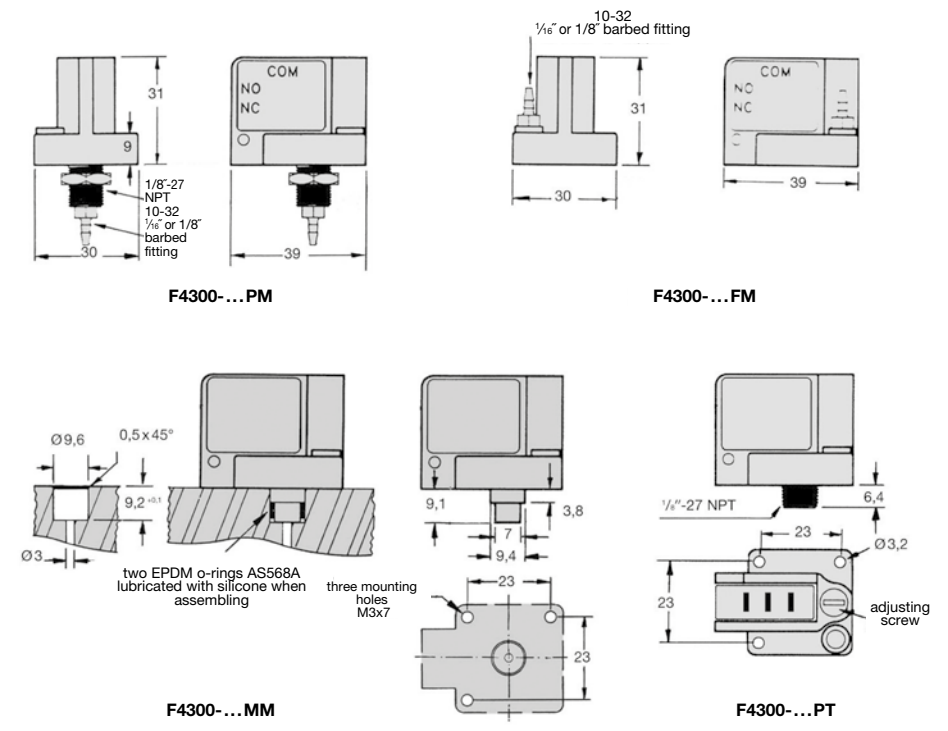

# PRESSURE SWITCH WITH ADJUSTABLE HYSTERESIS FOR PCB, TYPE "AIRROL®" F4000 / F4400

<b>Description</b>	High-precision pressure and vacuum switch with electrical outlet signal. The microswitch satisfies UL and CSA regulations. Polysulphone of the body approved by National Sanitation Foundation. The switch also complies with FDA regulations and is suitable for water and food products.		
<b>Media</b>	compressed air, non-corrosive gases or liquids		
<b>Switch contact</b>	micro SPDT switch, covered by plastic cap		
<b>Contact load</b>	15 A at 230 V AC, 1.2 A at 125 V DC	see chart, consultation needed for AT1004	
<b>Electrical connector</b>	3 A or 4 A at 230 V AC, 0.187" (4.75 mm) quick connector for Molex connector	see chart for F4000 and AT1004	
<b>Repeatability</b>	± 2% FS	for F4400	
<b>Certifications</b>	CSA-certified and UL-listed		
<b>Switching time</b>	25 ms		
<b>Mounting position</b>	any		
<b>Temperature range</b>	4 °C to 66 °C / 40 °F to 150 °F		
<b>Material</b>	Body: polysulphone	Spring: stainless steel	Media non-contact parts: nylon, carbon fibre nylon, acetal
	Diaphragm: polyurethane		

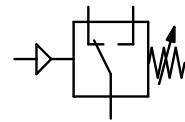

**4 ... 12 mbar / 7 bar**  
**-7 ... -170 mbar / -1 bar**

Description	Contact rating	Hysteresis typical	Over-pressure max.	Measurement range off	Measurement range on	Order number
	max. A	mbar	mbar	max. bar	mbar/bar	mbar/bar

Pressure and vacuum switch	with adjustable hysteresis nylon fitting, Ø 1/16", Ø 2 mm				F4000	
pressure switch	15	-	-	1	4... 12 mbar 6... 40 mbar	F4000- 20B80
	15	-	-	1	4... 37 mbar 8... 150 mbar	F4000- 30B80
vacuum switch	15	-	-	-1	-70...-380 mbar -135...-500 mbar	F4000- X B80

Pressure switch for PCB	with small hysteresis nylon fitting, Ø 1/16", Ø 2 mm				F4400	
pressure switch	3	7	14	2	0.014 ... 0.14 bar	F4400- 2B80
	4	14	24	2	0.035 ... 0.35 bar	F4400- 5B80
	4	30	41	3	0.035 ... 1.0 bar	F4400- 15B80
	4	40	70	4	0.035 ... 2.1 bar	F4400- 30B80
	4	100	170	8	0.035 ... 4.2 bar	F4400- 60B80
	4	140	240	8	0.070 ... 7.0 bar	F4400-100B80
vacuum switch	4	10	20	-1	-0.007 ... -0.17 bar	F4400-X 5B80
	4	20	34	-1	-0.015 ... -0.34 bar	F4400-X10B80
	4	30	50	-1	-0.050 ... -1.00 bar	F4400-X30B80

Pressure switch, factory-set	nylon fitting, ± 10% tolerance Ø 1/16", Ø 2 mm, SPDT switch		AT1004
pressure switch	switching point to be indicated on order		4...43 mbar
			AT1004-..B80

Special options,	add the appropriate letter		
barbed fitting	made of	nylon, Ø 1/8", Ø 4 mm	F4. 00- ... B85
		polysulphone, Ø 1/16", Ø 2 mm	F4. 00- ... P80
		polysulphone, Ø 1/8", Ø 4 mm	F4. 00- ... P85
factory-set switch point free of oil and grease	± 5%, switching point to be indicated on order		F4. 00- ... X
	specialy cleaned, suitable for oxygen		F4. 00- ... L



F4000-30B80



F4400-100B80



AT1004-17



cover cap for pressure switch supplied

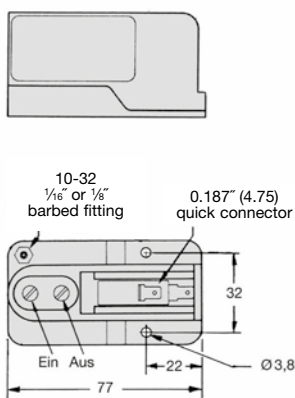

F4000

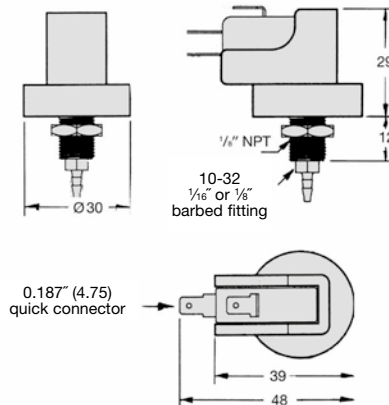

AT1004

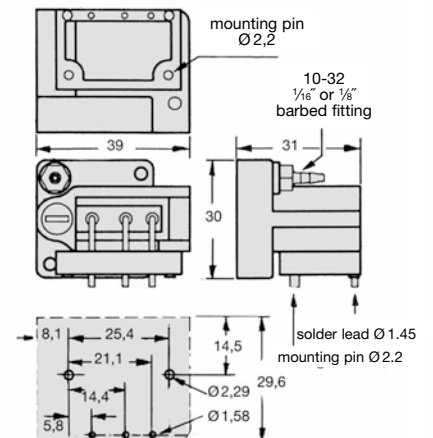

F4400

\*1 not adjustable





<b>Description</b>	Pilot-actuated pressure valve with precisely adjustable pilot setpoint. Perfect for applications which require intrinsic safety, pneumatic sequencing or pressure relief. Valves are normally opened or closed. The switch complies with FDA regulations and is suitable for water and food products.		
<b>Media</b>	5 µm filtered compressed air		
<b>Pressure valve</b>	3-port/2-way air-assisted servo valve with exhaust to atmosphere, NO or NC, made of nylon Supply pressure: 1.4...8 bar, untapped exhaust Air consumption: max. 0.3 l/min at 2 bar supply pressure or max. 0.7 l/min at 7 bar Pneumatic connection: quick connector for hose external diameter of 4 mm (5/32") Flow rate: 70 l/min at 7 bar, nominal size DN 0.2, K <sub>v</sub> = 0.05 Switching time: 64 ms at 6 bar supply pressure		
<b>Accuracy</b>	Pressure switch: at supply pressure variation of 0.7 bar: < 7 mbar pressure deviation Vacuum switch: at supply pressure variation of 0.3 bar: < 3 mbar pressure deviation Repeatability: ± 2% FS		
<b>Temperature range</b>	4 °C to 60 °C / 40 °F to 140 °F		
<b>Material</b>	Body: polysulphone	Spring: stainless steel	Media non-contact parts: nylon, carbon fibre nylon, acetal

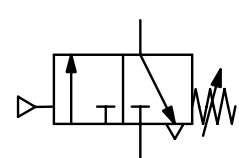

**70 ... 350 mbar / 7 bar**  
**-30 ... -170 / -850 mbar**

Switches



12

Description	Supply pressure of switching valve	Hysteresis typical mbar	Hysteresis max. mbar	Over-pressure max. bar	Measurement range bar	Order number
-------------	------------------------------------	-------------------------	----------------------	------------------------	-----------------------	--------------

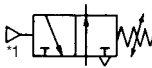
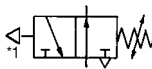
Switch with pneumatic output, NO	1/8" NPT male, supply pressure 1.4...8 bar		PP / VP700			
 <p>pressure switch</p>	1.4 ... 8 bar	15	30	2	0.07 ... 0.35	<b>PP700- 5PT</b>
		20	40	4	0.07 ... 1.0	<b>PP700- 15PT</b>
	NO	20	70	4	0.07 ... 2.1	<b>PP700- 30PT</b>
		35	140	8	0.20 ... 4.2	<b>PP700- 60PT</b>
		50	240	8	0.35 ... 7.0	<b>PP700-100PT</b>
 <p>vacuum switch</p>	1.4 ... 8 bar	15	35	-1	-0.03 ... -0.17	<b>VP700- 5PT</b>
		20	40	-1	-0.03 ... -0.34	<b>VP700- 10PT</b>
	NO	35	70	-1	-0.07 ... -0.85	<b>VP700- 30PT</b>

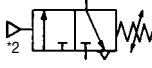
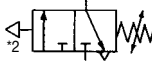

PP700-100PT

Switch with pneumatic output, NC	1/8" NPT male, supply pressure 1.4...8 bar		PP / VP701			
 <p>pressure switch</p>	1.4 ... 8 bar	15	30	2	0.07 ... 0.35	<b>PP701- 5PT</b>
		20	40	4	0.07 ... 1.0	<b>PP701- 15PT</b>
	NC	20	70	4	0.07 ... 2.1	<b>PP701- 30PT</b>
		35	140	8	0.20 ... 4.2	<b>PP701- 60PT</b>
		50	240	8	0.35 ... 7.0	<b>PP701-100PT</b>
 <p>vacuum switch</p>	1.4 ... 8 bar	15	35	-1	-0.03 ... -0.17	<b>VP701- 5PT</b>
		20	40	-1	-0.03 ... -0.34	<b>VP701- 10PT</b>
	NC	35	70	-1	-0.07 ... -0.85	<b>VP701- 30PT</b>



PP700-15PM

**Special options, add or change the appropriate letter**

<b>flush mounting</b>	barbed fitting made of nylon,	Ø 1/16", Ø 2 mm	.P70.-... <b>FMB80</b>
<b>panel mounting</b>	barbed fitting made of nylon,	Ø 1/16", Ø 2 mm	.P70.-... <b>PMB80</b>
<b>manifold mounting</b>			.P70.-... <b>MM</b>
<b>barbed fitting</b>	for FM and PM,	nylon, Ø 1/16", Ø 2 mm	.P70.-... <b>B80</b>
		nylon, Ø 1/8", Ø 4 mm	.P70.-... <b>B85</b>
		polysulphone, Ø 1/16", Ø 2 mm	.P70.-... <b>P80</b>
		polysulphone, Ø 1/8", Ø 4 mm	.P70.-... <b>P85</b>
<b>free of grease and oil</b>	specially cleaned, suitable for oxygen		.P70.-... <b>L</b>

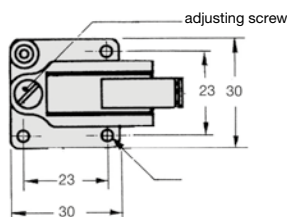

PP / VP70

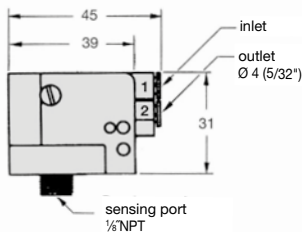

B80 / P80

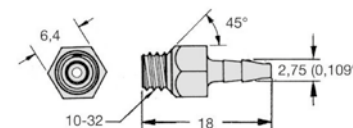

B85 / P85

\*1 only output signal in the absence of input signal (positive pressure, vacuum)  
\*2 no output signal in the absence of input signal (positive pressure, vacuum)



# PROGRAMMABLE VACUUM AND PRESSURE SWITCH TRANSDUCER WITH DISPLAY DSB / DSC

<b>Description</b>	Pressure to the unit is continuously monitored by a piezo-resistive sensor and converted into a proportional voltage signal. The signal is then amplified and delivered as a PNP signal. dry, lubricated or unlubricated compressed air or non-corrosive gases		
<b>Media</b>	12 ... 30 V DC, reverse voltage protection, current consumption max. 30 mA, output current max. 250 mA		
<b>Supply voltage</b>	Mode: hysteresis or window, switching point and hysteresis, NO or NC, closing or opening time, bar, psi, MPa, kg/cm <sup>2</sup> etc. Display: current pressure, highest pressure, measurement errors		
<b>Adjustment</b>	<b>DSB</b>	2x PNP freely programmable as NO or NC, max. contact load 250 mA, short-circuit-proof	
<b>Switching output</b>	<b>DSB</b>	1x PNP as at DSB and 1x analogue output signal 1...5 V, output impedance < 500 Ω	
<b>Switching output</b>	<b>DSC</b>	adjustable from 0% to 100% of set switching point	
<b>Hysteresis</b>	Linearity < 1% FS		
<b>Repeatability</b>	Switching frequency 200 Hz		
<b>LED display</b>	Mounting position any		
<b>Error display</b>	Shock resistance 10 g		
<b>Certifications</b>	Protection class IP 65		
<b>Temperature range</b>	Connection thread: nickel-plated brass		
<b>Material</b>	Body: ABS-PC plastic, shockproof		

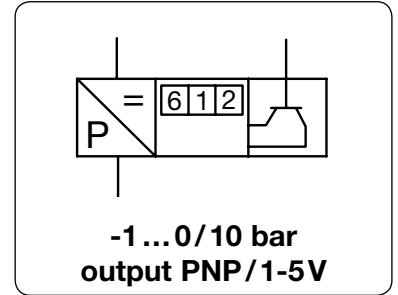

Switches



12

Dimensions	Digital display	Over-pressure	Output signal type	Measurement range	Order number
B	Ø	max. bar	PNP/analog	bar	
mm	mm		max. mA		

Sensor pressure switch					connection thread G½ male, without coupling socket, M8x1, 4-pin	DS	
57	16	with	2	2x PNP	250	0 ... -1 -1 ... +1 0 ... 10 -1 ... 10 0 ... 12	<b>DSB-V1</b> <b>DSB-V2</b> <b>DSB-10</b> <b>DSB-V10</b> <b>DSB-12</b>
44	16	without	2	1x PNP/1x analog	250	0 ... -1 -1 ... +1 -1 ... 10	<b>DSC-V1</b> <b>DSC-V2</b> <b>DSC-V10</b>



DSB with digital display



DSC

## Accessories, enclosed

<b>coupling socket</b>	M8x1, 4-pin with 5 m cable	straight	<b>KM8-A4-5</b>
		angular	<b>KM8-C4-5</b>

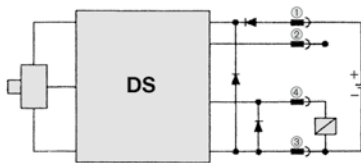

connection diagram

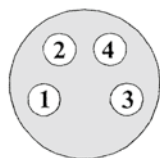

PIN configuration according to DIN EN 50044

PIN configuration DIN EN 50044		
pin	colour	configuration
1	brown	24 V DC (+)
2	white	outlet 2 / analog
3	blue	24 V DC (-)
4	black	outlet 1 / digital

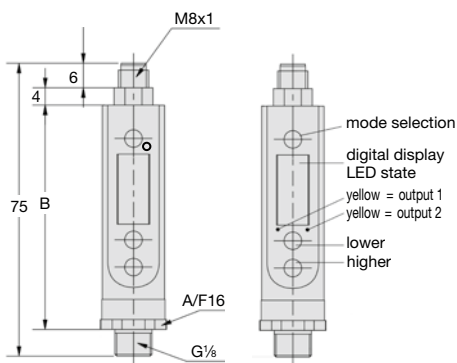
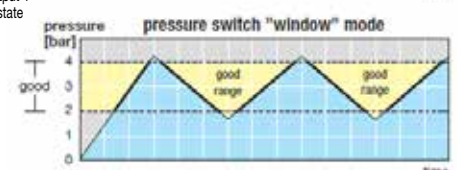
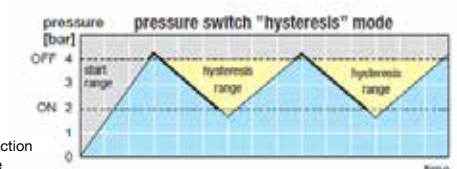
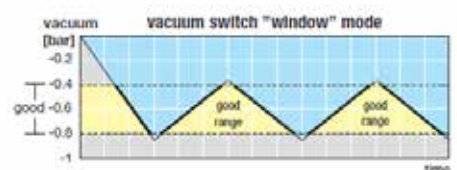
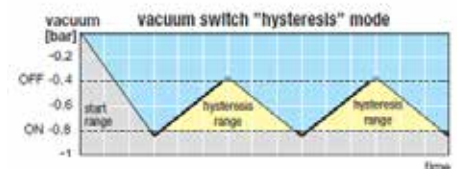

DSB

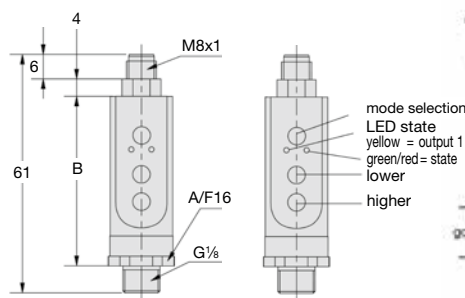

DSC

PDF CAD  
www.aircom.net



Order example:  
DSB-V1